

TRACK & SURFACE - SPOTS

R = TRACK MOUNT

S = SURFACE MOUNT

R028 / S028
"ROUND"
Spot

White
Black
Silver



50W GZ10 50W MR16

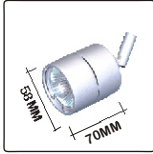

R201 / S201
"DOME SHADE"
Spot

White
Black
Silver



50W MR16

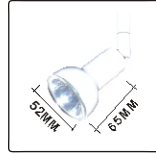

R205 / S205
"PIXIE"
Spot

White
Black
Silver
Brushed

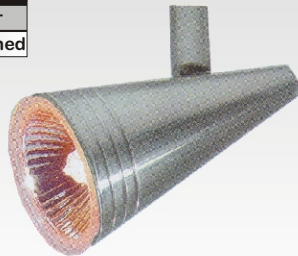

50W MR16

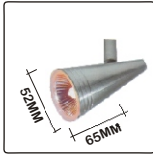

USE ALUMINIUM BACKED "ALU" LAMPS ONLY

R226 / S226
"WINGED"
Spot

White
Black
Silver



50W MR16

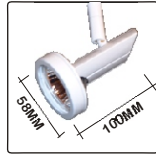

R229 / S229
"CONICAL"
Spot

White
Black
Silver



50W MR16



R230 / S230
"BASIC"
Spot

Chrome
White
Black
Silver



50W MR16



R300 / S300
"M3"
Spot





White
Black
Silver





50W MR16



Photometrics for Osram 46870SP 50W dichroic lamp

H(M)	∅	10°	E(lux)
0.3	12		97800
0.5	20		41800
1.0	40		11000
2.0	80		2800

Photometrics for Osram 46870WFL 50W dichroic lamp

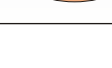



H(M)	∅	38°	E(lux)
0.3	29		17400
0.5	48		7440
1.0	97		2000
2.0	194		490

TRACK & SURFACE - SPOTS





R = TRACK MOUNT

S = SURFACE MOUNT

Photometrics for
Osram 46870SP
50W dichroic lamp

H(M)	∅	10°	E(lux)
0.3	12		97800
0.5	20		41800
1.0	40		11000
2.0	80		2800

Photometrics for
Osram 46870WFL
50W dichroic lamp

H(M)	∅	38°	E(lux)
0.3	29		17400
0.5	48		7440
1.0	97		2000
2.0	194		490

R503 / S503
"NEPRO QI"
Flood

Silver

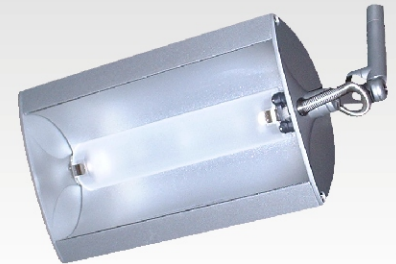

300W
QI R7s

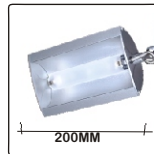

Quartz Halogen Floodlight

R515 / S515
"LIMA"
Spot

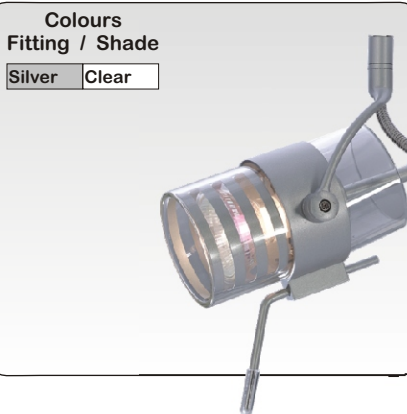

Colours
Fitting / Shade

Silver Clear

50W
GZ10

50W
MR16

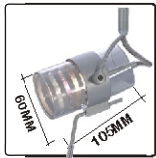

R531 / S531
"SYROS"
Spot
with GLASS

Silver

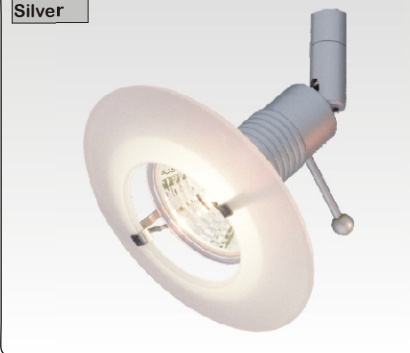

50W
MR16

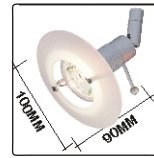

R540 / S540
"STAR"
Spot



White
Black
Chrome
Silver

SUPPLIED WITH MATCHING
METAL SHADE

50W
MR16

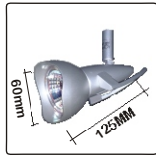

ALSO AVAILABLE WITH FROSTED
OR BLUE GLASS SHADE (SAME SHAPE)

R550 / S550
"LIKA"
Spot

Silver

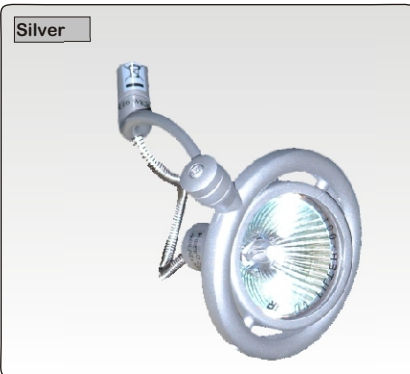

50W
MR16



R581 / S581
"ROCKET"
Spot
with MESH

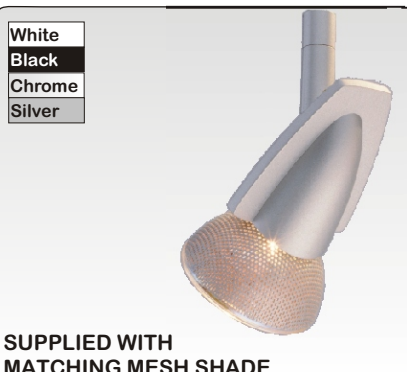

White
Black
Chrome
Silver

SUPPLIED WITH
MATCHING MESH SHADE

50W
MR16

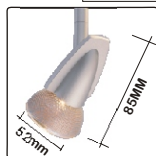

R599 / S599
"ARGON"
Spot

Silver



50W
GZ10

50W
MR16

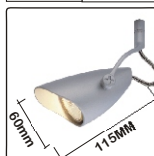

TRACK & SURFACE - ACCESSORIES



TRACK ACCESSORIES

RTR - Track (2 Wire)

White, Black and Silver available in 1m, 1.5m, 2m and 3m

White
Black
Silver



MAXIMUM 16A
4 x 50W 12V FITTINGS

RCS - Track Straight Connector

White
Black
Silver

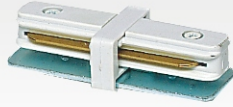

RCL - Track "L" Connector

White
Black
Silver

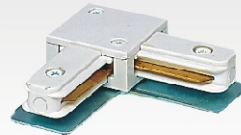

RCT - Track "T" Connector

White
Black
Silver

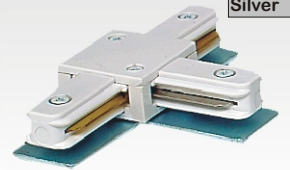

RCF - Track Flexible Bend

White
Black

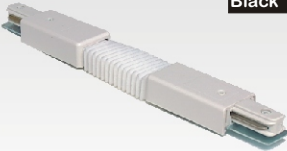

ALSO SUPPLIED IN SILVER WITH WHITE FLEXIBLE INSERT

RPF - Floating Canopy Power Feed for Track

White
Black
Silver

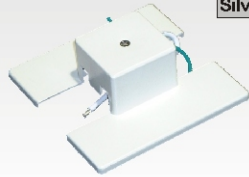

CAN BE USED AS A CENTRE FEED

RCX - Track "X" Connector

White
Black
Silver

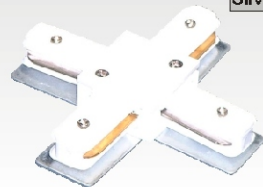

RTA - Track Adaptor w/o Transformer

White
Black
Silver



USED FOR PAR16 SPOTS AND 12V SPOTS w. REMOTE TRANSFORMERS

TRANSFORMER NOT SUPPLIED
REQUIRES REMOTE TRANSFORMER
(MAX 200VA PER TRACK CIRCUIT)

Photometrics for Osram 46870SP 50W dichroic lamp

H(M)	∅	10°	E(lux)
0.3	12		97800
0.5	20		41800
1.0	40		11000
2.0	80		2800

Photometrics for Osram 46870WFL 50W dichroic lamp

H(M)	∅	38°	E(lux)
0.3	29		17400
0.5	48		7440
1.0	97		2000
2.0	194		490

CHECK OUT THE PENDANT OPTIONS ELSEWHERE IN THIS CATALOGUE



RT2 - Track Adaptor 90L x 35W x 25H

White
Black
Silver



RT3 - Track Adaptor 120L x 35W x 25H



SUPPLIED WITH 50VA ELECTRONIC TRANSFORMER



SURFACE MOUNT ACCESSORIES

ST2 / ST3 Rect. Base w. Transformer

White
Black
Chrome
Silver



Supplied with individual electronic transformers
360mm long x 90mm wide

SS3 - Surface Mount "Mouse" w. Transformer 100L x 60W x 30H

White
Black
Silver



SUPPLIED WITH 50VA ELECTRONIC TRANSFORMER

SS4 - Flush Ceiling Plate w/o Transformer 38mm dia

White
Black
Chrome
Silver

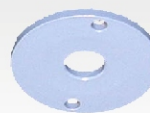

TRANSFORMER NOT SUPPLIED
REQUIRES REMOTE TRANSFORMER

SS5 - Recessed Ceiling Plate w/o Transformer 80dia

White
Black
Chrome
Silver



63mm

TRANSFORMER NOT SUPPLIED
REQUIRES REMOTE TRANSFORMER

RE - Rod Extensions Standard Length 1000mm

Powdercoated or Anodised 12.5mm OD Aluminium Rod extensions for most Spots

White
Black
Chrome
Silver



SS7 - Surface Mount Large Round w/o Transformer 100dia x 20H

White
Black
Chrome
Silver



TRANSFORMER NOT SUPPLIED
REQUIRES REMOTE TRANSFORMER

SS8 - Surface Mount Large Round w. Transformer 100dia x 35H

White
Black
Chrome
Silver



SUPPLIED WITH 50VA TOROIDAL TRANSFORMER

SR2 / SR3 Round Base w. Transformer

White
Chrome
Silver



Supplied with single toroidal (wire wound) Transformer

205mm

55mm

Cable and Rod Options

BuyLighting
Sharecall (0860) LIGHTS
email: sales@buylighting.co.za
http://www.buylighting.co.za

R
A1